

drainland®

DRENAJ
KANALLAR
DRAINGATE
CHANNEL

**Kaliteli yaşamın
alt yapısı ...**

Your quality life
substructure ...



Dayanıklı
Resistant



Kolay Montaj
Easy Assembly



Kolay Temizlik
Easy Cleaning



www.mesateknik.com

index

PLASTİK DRENAJ KANALLAR
PLASTIC DRAINAGE
CHANNELS



POLİMER DRENAJ KANALLAR
POLYMER DRAINAGE
CHANNELS



PASLANMAZ VE GALVANİZ IZGARALAR
STAINLESS AND GALVANISED
MATERIEL GRILL



DÖKÜM IZGARALAR
CAST IRON GRILL



SLIMLINE OLUKLU
KANAL VE IZGARA
SİSTEMLERİ
CORRUGATED
GRATE SYSTEMS



POINT DRAIN
SİFONLU SÜZGEÇLER
POINT DRAIN
SIPHONIC
DRAINS



IRON DRAIN
SİFONLU SÜZGEÇLER
IRON DRAIN
SIPHONIC
DRAINS



ÇEKVALFLAR
BACK WATER VALVE



RÖGAR KUTUSU VE KAPAKLAR
MANHOLE
AND ANTI
FLOODING



KOMPOZİT KARE KAPAKLAR
COMPOSITE
SQUARE COVER



POLİMER KAPAKLAR
POLYMER MENHOLE
COVER



DÖŞEME UYUMLU GİZLEME KAPAKLARI
UPHOLSTERY COMPATIBLE
CONCEALMENT
COVER



GENİŞLİK WIDTH	YÜKSEKLİK HEIGHT	UZUNLUK LENGTH
7 cm	6.5 cm	50 cm

PLASTİK DRENAJ KANAL

PLASTIC
DRAINAGE CHANNELS

MTS 1070

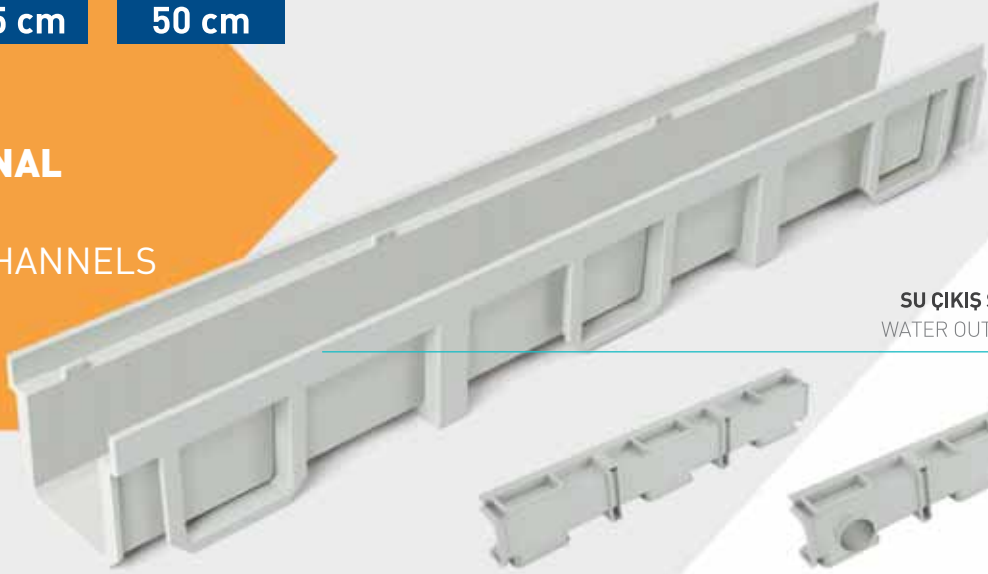

SU ÇIKIŞ SEÇENEKLERİ WATER OUTLET OPTIONS

MTS 1070

MTS 1170
alt çıkış Ø50
vertical outlet Ø50

Ürünlerimiz direkt güneş ışınlarından, U.V ışınlarından etkilenmez renkleri solmaz, zamana ve kimyasal tepkimelere karşı mukavemet gösterecek biçimde dizayn edilmiştir.

Our products are not affected by sun light and UV rays. They don't loose their colour.



MTS 1070

7x50 cm Plastik Kanal
Kanal yüksekliği : 6,5 cm
Alt Çıkış
7x50 cm Plastic Channel
Channel Height : 6,5 cm
Vertical Outlet

Koli Adedi: 40 Box Quantity:40

MTS 2070-06

7x50 cm Paslanmaz Izgara
7x50 cm Stainless Grill

Koli Adedi: 40 Box Quantity:40



Ø50 Çıkış
Ø50 Outlet

MTS 1071

7x6,5 cm Kanal Tapası
7x6,5 cm Channel Cap

Koli Adedi: 100
Box Quantity:100



MTS 1070

7x50 cm Plastik Kanal
Kanal yüksekliği : 6,5 cm
Alt Çıkış
7x50 cm Plastic Channel
Channel Height : 6,5 cm
Vertical Outlet

Koli Adedi: 40 Box Quantity:40

MTS 1072

7x50 cm Plastik Izgara
7x50 cm Plastic Grill

Koli Adedi: 40 Box Quantity:40

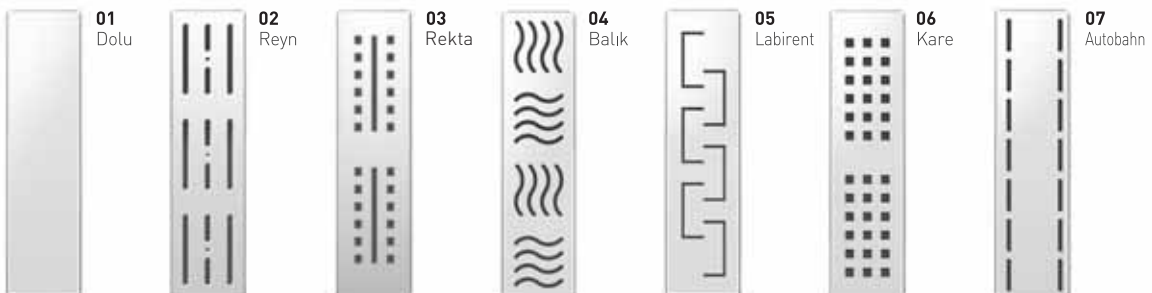

GENİŞLİK
WIDTH

10 cm

YÜKSEKLİK
HEIGHT

5 cm

UZUNLUK
LENGTH

50 cm

**PLASTİK
DRENAJ KANAL**PLASTIC
DRAINAGE CHANNELS**MTS 2035****SU ÇIKIŞ SEÇENEKLERİ**
WATER OUTLET OPTIONS**MTS 2035****MTS 2135**

alt çıkış Ø50 / Ø70

vertical outlet Ø50 / Ø70

Polipropilen üretilmiş 50 cm uzunluğundaki modüler su kanallarımız tüm özel uygulama ihtiyaçlarına cevap veren komple bir ürün setidir. Birbirine conta ihtiyacı olmadan kilitlenebilen mekanizması sayesinde, estetik yapıdaki dizaynı ile kanal projelerinizde eşsiz bir çözüm sunar.

Our polypropylene 50cm long modular water drain system is a complete product set that can meet any custom requirement. Thanks to its locking mechanism without any kind of seal between, it can bring unique solutions to any type of drain project along with its artistic view.

Ø32 Çıkış
Ø32 Outlet**MTS 2036**10x5 cm
Kanal Tapası10x5 cm
Channel CapKoli Adedi: 100
Box Quantity:100**MTS 2035**10x50 cm Plastik Kanal
Kanal yüksekliği : 5 cm
10x50 cm Plastic Channel
Channel Height : 5 cm

Koli Adedi: 40 Box Quantity:40

MTS 203710x50 cm Plastik Izgara
10x50 cm Plastic Grill

Koli Adedi: 40 Box Quantity:40

**MTS 2035**10x50 cm Plastik Kanal
Kanal yüksekliği : 5 cm
10x50 cm Plastic Channel
Channel Height : 5cm

Koli Adedi: 40 Box Quantity:40

MTS 213810x50 cm Paslanmaz Izgara
Kare Desen
10x50 cm Stainless Grill
Square Pattern

Koli Adedi: 30 Box Quantity:30

**MTS 2135**10x50 cm Plastik Kanal
Kanal yüksekliği : 5 cm - Alt Çıkış
10x50 cm Plastic Channel
Channel Height : 5 cm - Vertical Outlet

Koli Adedi: 30 Box Quantity:30

MTS 213810x50 cm Paslanmaz Izgara
Kare Desen
10x50 cm Stainless Grill
Square Pattern

Koli Adedi: 30 Box Quantity:30

GENİŞLİK WIDTH	YÜKSEKLİK HEIGHT	UZUNLUK LENGTH
13 cm	7.5 cm	50 cm

PLASTİK DRENAJ KANAL

PLASTIC
DRAINAGE CHANNELS

MTS 1035



SU ÇIKIŞ SEÇENEKLERİ
WATER OUTLET OPTIONS

MTS 1035

MTS 1135
alt çıkış Ø50 / Ø70
vertical outlet Ø50 / Ø70



MTS 1035

13x50 cm Plastik Kanal
Kanal yüksekliği : 7.5 cm
13x50 cm Plastic Channel
Channel Height : 7.5 cm

Koli Adedi: 40 Box Quantity:40

MTS 1037

13x50 cm Standart Desen
Plastik Izgara
13x50 cm Standard Pattern
Stainless Grill

Koli Adedi: 40 Box Quantity:40



MTS 1035

13x50 cm Plastik Kanal
Kanal yüksekliği : 7.5 cm
13x50 mm Plastic Channel
Channel Height : 7.5 cm

Koli Adedi: 40 Box Quantity:40

MTS 1438

13x50 cm Standart Desen
Galvaniz Esaslı
13x50 cm Standart Pattern
Galvanised Stainless

Koli Adedi: 40 Box Quantity:40



MTS 1035

13x50 cm Plastik Kanal
Kanal yüksekliği : 7.5 cm
13x50 cm Plastic Channel
Channel Height : 7.5 cm

Koli Adedi: 40 Box Quantity:40

MTS 1038

13x50 cm Paslanmaz Izgara
Standart Desen
13x50 cm Stainless Grill
Standard Pattern

Koli Adedi: 40 Box Quantity:40



MTS 1135

13x50 cm Plastik Kanal
Kanal yüksekliği : 7.5 cm - Alt Çıkış
13x50 cm Plastic Channel
Channel Height : 7.5 cm - Vertical Outlet

Koli Adedi: 35 Box Quantity:35

MDI 1350

13x50 cm Döküm Izgara
13x50 cm Sphero Cast Grill

Koli Adedi: 35
Box Quantity:35



Ø50 Çıkış
Ø50 Outlet

MTS 1036

13x7.5 cm
Kanal Tapası
13x7.5 cm
Channel Cap

Koli Adedi: 100
Box Quantity:100

GENİŞLİK
WIDTH

13 cm

YÜKSEKLİK
HEIGHT

7.5 cm

UZUNLUK
LENGTH

50 cm

PLASTİK DRENAJ KANAL

PLASTIC
DRAINAGE CHANNELS

MTS 1035-S

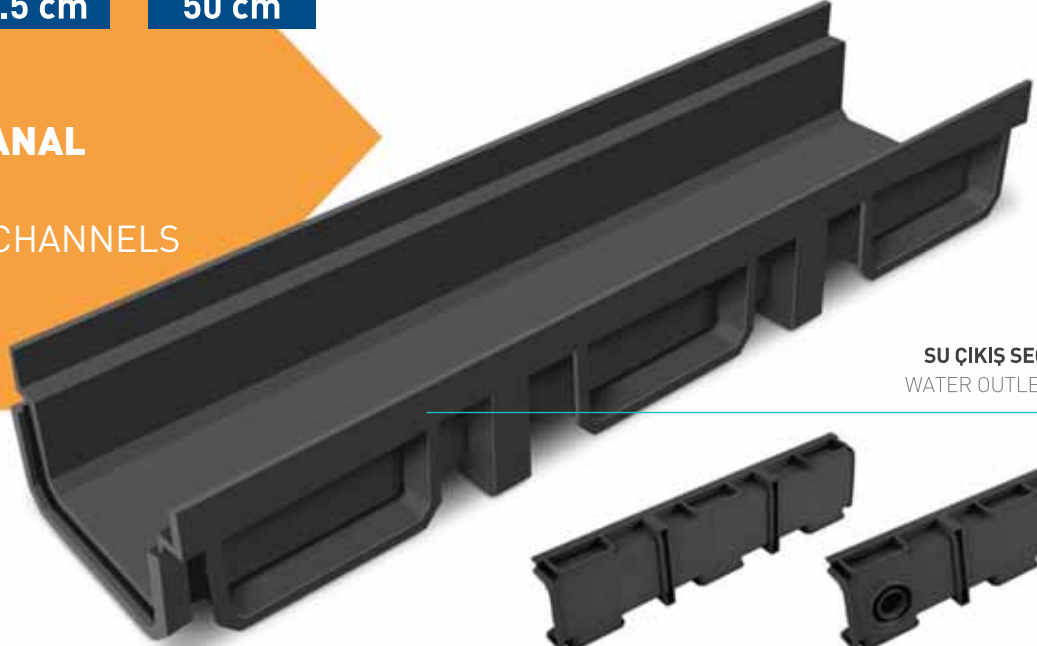

SU ÇIKIŞ SEÇENEKLERİ
WATER OUTLET OPTIONS

MTS 1035-S

MTS 1135-S

alt çıkış Ø50 / Ø70

vertical outlet Ø50 / Ø70



MTS 1035-S

13x50 cm Plastik Kanal
Kanal yüksekliği : 7.5 cm
13x50 cm Plastic Channel
Channel Height : 7.5 cm

Koli Adedi: 40 Box Quantity:40

MTS 1037-S

Standart Desen
Plastik Izgara
Standard Pattern
Stainless Grill

Koli Adedi: 40 Box Quantity:40



MTS 1035-S

13x50 cm Plastik Kanal
Kanal yüksekliği : 7.5 cm
13x50 cm Plastic Channel
Channel Height : 7.5 mm

Koli Adedi: 40 Box Quantity:50

MTS 1438

13x50 cm Standart Desen
Galvaniz Esaslı
13x50 cm Standart Pattern
Galvanised Stainless

Koli Adedi: 40 Box Quantity:40



MTS 1035-S

13x50 cm Plastik Kanal
Kanal yüksekliği : 7.5 cm
13x50 cm Plastic Channel
Channel Height : 7.5 cm

Koli Adedi: 40 Box Quantity:40

MTS 1038

13x50 cm Paslanmaz Izgara
Standart Desen
13x50 cm Stainless Grill
Standard Pattern

Koli Adedi: 40 Box Quantity:40



MTS 1135-S

13x50 cm Plastik Kanal
Kanal yüksekliği : 7.5 cm - Alt Çıkış
13x50 cm Plastic Channel
Channel Height : 7.5 cm - Vertical Outlet

Koli Adedi: 35 Box Quantity: 35

MDI 1350

13x50 cm Döküm Izgara
13x50 cm Sphero Cast Grill

Koli Adedi: 35
Box Quantity: 35



Ø50 Çıkış
Ø50 Outlet

MTS 1036-S

13x7.5 cm
Kanal Tapası
13x7.5 cm
Channel Cap

Koli Adedi: 100
Box Quantity:100

GENİŞLİK WIDTH	YÜKSEKLİK HEIGHT	UZUNLUK LENGTH
20 cm	8 cm	50 cm

PLASTİK DRENAJ KANAL

PLASTIC
DRAINAGE CHANNELS

MTS 2042

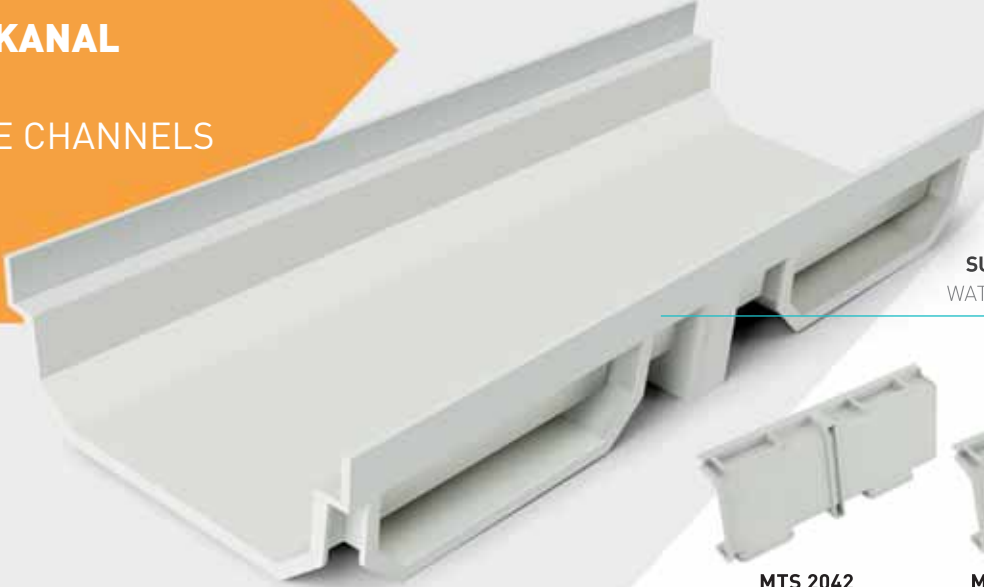

SU ÇIKIŞ SEÇENEKLERİ
WATER OUTLET OPTIONS



MTS 2042



MTS 2142

alt çıkış Ø70 / Ø100
vertical outlet
Ø70 / Ø100



Ø50 Çıkış
Ø50 Outlet

MTS 2043

20x8 cm
Kanal Tapası
20x8 cm
Channel Cap

Koli Adedi: 100
Box Quantity:100



MTS 2042

20x50 cm Plastik Kanal
Kanal yüksekliği : 8 cm
20x50 cm Plastic Channel
Channel Height : 8 mm

Koli Adedi: 20 Box Quantity:20

MTS 1044

20x50 cm Plastik Izgara
20x50 cm Plastic Grill

Koli Adedi: 20 Box Quantity:20

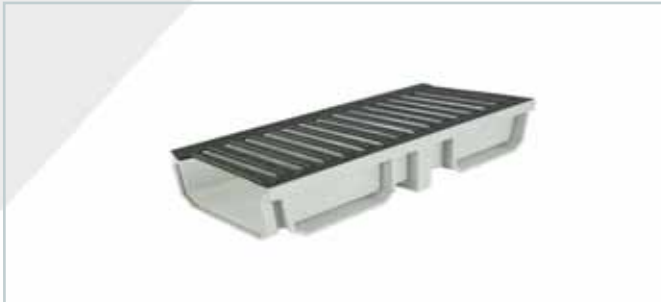

MTS 2042

20x50 cm Plastik Kanal
Kanal yüksekliği : 8 cm
20x50 cm Plastic Channel
Channel Height : 8 cm

Koli Adedi: 20 Box Quantity:20

MDI 2050

20x50 cm Döküm Izgara
20x50 cm Sphero Cast Grill

Koli Adedi: 20
Box Quantity:20



MTS 2142

20x50 cm Plastik Kanal
Kanal yüksekliği : 8 cm - Alt Çıkış
20x50 cm Plastic Channel
Channel Height : 8 cm - Vertical Outlet

Koli Adedi: 15 Box Quantity: 15

MTS 1040

20x50 cm Paslanmaz Izgara
Standart Desen
20x50 cm Stainless Grill
Standard Pattern

Koli Adedi: 15 Box Quantity:15

GENİŞLİK
WIDTH

20 cm

YÜKSEKLİK
HEIGHT

12 cm

UZUNLUK
LENGTH

50 cm

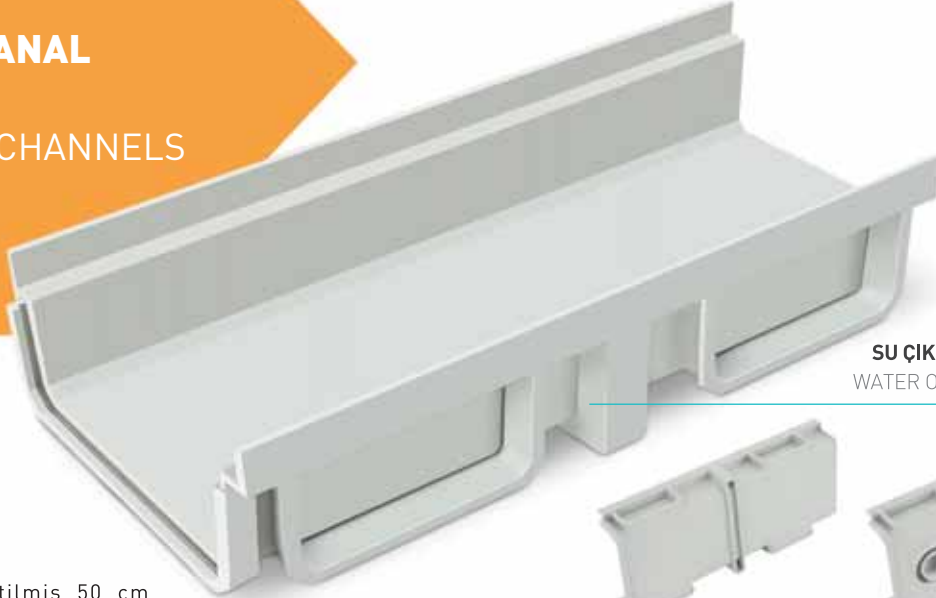
**PLASTİK
DRENAJ KANAL****PLASTIC
DRAINAGE CHANNELS****MTS 1042****SU ÇIKIŞ SEÇENEKLERİ**
WATER OUTLET OPTIONS**MTS 1042****MTS 1142**alt çıkış Ø70 / Ø100
vertical outlet Ø70 / Ø100

Polipropilen üretilmiş 50 cm uzunluğundaki modüler su kanallarımız tüm özel uygulama ihtiyaçlarına cevap veren komple bir ürün setidir. Birbirine conta ihtiyacı olmadan kilitlenebilen mekanizması sayesinde, estetik yapıdaki tasarımı ile kanal projelerinizde eşsiz bir çözüm sunar.

Our polypropylene 50cm long modular water drain system is a complete product set that can meet any custom requirement. Thanks to its locking mechanism without any kind of seal between, it can bring unique solutions to any type of drain project along with its artistic view.

Ø70 - Ø100 Çıkış
Ø70 - Ø100 Outlet**MTS 1043**20x12 cm
Kanal Tapası
20x12 cm
Channel CapKoli Adedi: 100
Box Quantity:100**MTS 1042**20x50 cm Plastik Kanal
Kanal yüksekliği : 12 cm
20x50 cm Plastic Channel
Channel Height : 12 cm

Koli Adedi: 12 Box Quantity:12

MTS 104420x50 cm Plastik Izgara
20x50 cm Plastic Grill

Koli Adedi: 20 Box Quantity:20

**MTS 1042**20x50 cm Plastik Kanal
Kanal yüksekliği : 12 cm
20x50 cm Plastic Channel
Channel Height : 12 cm

Koli Adedi: 12 Box Quantity:12

MDI 205020x50 cm Döküm Izgara
20x50 cm Sphero Cast GrillKoli Adedi: 12
Box Quantity:12**MTS 1142**20x50 cm Plastik Kanal
Kanal yüksekliği : 12 cm - Alt Çıkış
20x50 mm Plastic Channel
Channel Height : 12 cm - Vertical Outlet

Koli Adedi: 10 Box Quantity:10

MTS 104020x50 cm Paslanmaz Izgara
Standart Desen
20x50 cm Stainless Grill
Standard Pattern

Koli Adedi: 10 Box Quantity:10

GENİŞLİK
WIDTH

13 cm

 YÜKSEKLİK
HEIGHT

7.5 cm

 UZUNLUK
LENGTH

100 cm

PLASTİK DRENAJ KANAL

PLASTIC DRAINAGE CHANNELS

MTS 3035

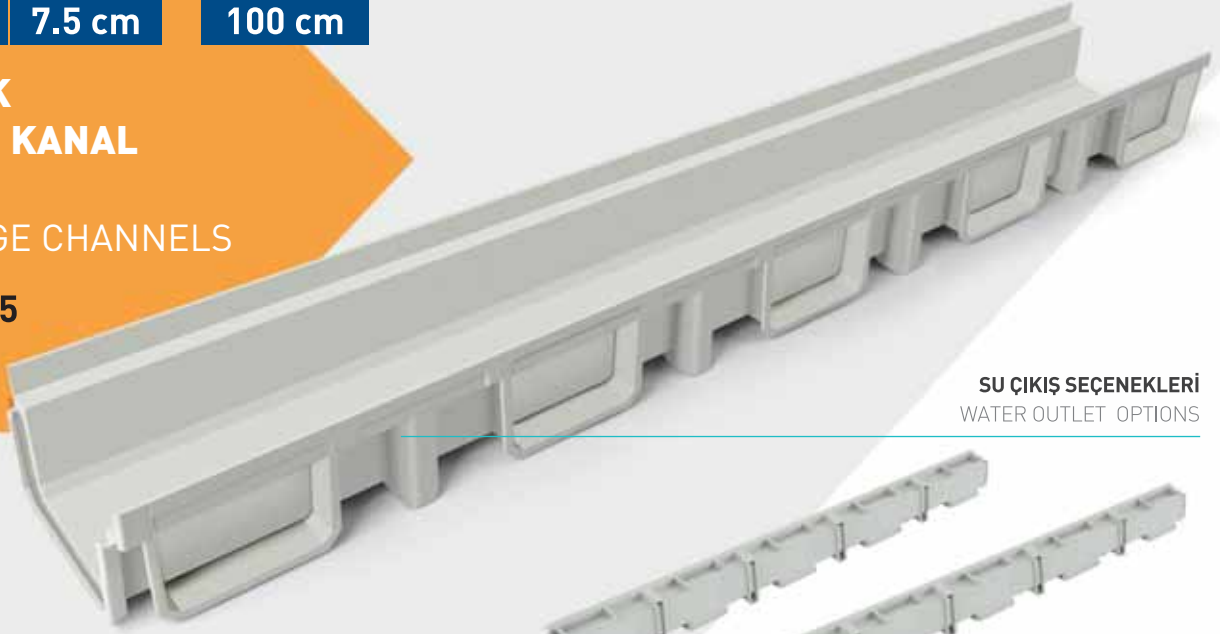

SU ÇIKIŞ SEÇENEKLERİ WATER OUTLET OPTIONS

Polipropilen üretilmiş 100 cm uzunluğundaki modüler su kanallarımız tüm özel uygulama ihtiyaçlarına cevap veren komple bir ürün setidir. Birbirine conta ihtiyacı olmadan kilitlenebilen mekanizması sayesinde, estetik yapıdaki tasarımı ile kanal projelerinizde eşsiz bir çözüm sunar.

Our polypropylene 100 cm long modular water drain system is a complete product set that can meet any custom requirement. Thanks to its locking mechanism without any kind of seal between, it can bring unique solutions to any type of drain project along with its artistic view.



Ø50 Çıkış
Ø50 Outlet

MTS 1036

13x7.5 cm
Kanal Tapası
13x7.5 cm
Channel Cap

Koli Adedi: 100
Box Quantity:100



MTS 3035

13x100 cm Plastik Kanal
Kanal yüksekliği : 7.5 cm
13x100 cm Plastic Channel
Channel Height : 7.5 cm

Koli Adedi: 20 Box Quantity:20

MTS 1037(2)

13x50 cm Standart Desen
Plastik Izgara
13x50 cm Standard Pattern
Stainless Grill

Koli Adedi: 40 Box Quantity:40



MTS 3035

13x100 cm Plastik Kanal
Kanal yüksekliği : 7.5 cm
13x100 mm Plastic Channel
Channel Height : 7.5 cm

Koli Adedi: 20 Box Quantity:20

MTS 1039

13x100 cm Paslanmaz Izgara
Standart Desen
13x100 cm Stainless Grill
Standard Pattern

Koli Adedi: 20 Box Quantity:20



MTS 3135

13x100 cm Plastik Kanal
Kanal yüksekliği : 7.5 cm - Alt Çıkış
13x100 cm Plastic Channel
Channel Height : 7.5 cm - Vertical Outlet

Koli Adedi: 15 Box Quantity:15

MTS 1439

13x100 cm Standart Desen
Galvaniz Esaslı
13x100 cm Standart Pattern
Galvanised Stainless

Koli Adedi: 15 Box Quantity: 15

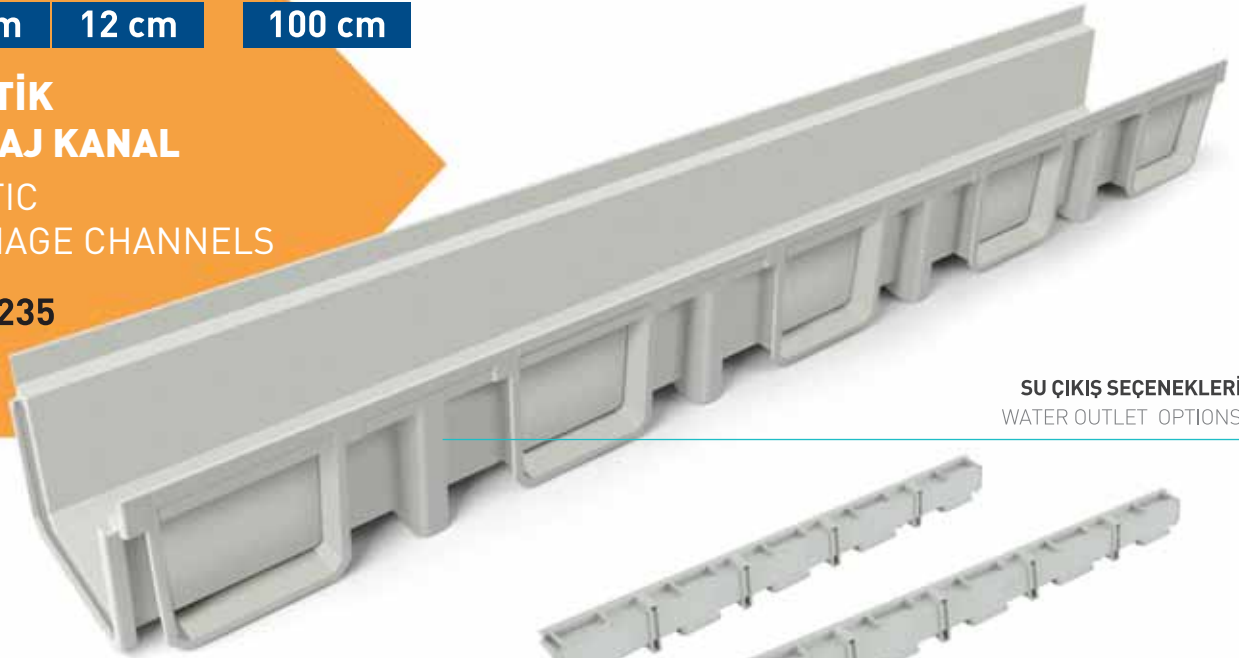
GENİŞLİK
WIDTH**13 cm**YÜKSEKLİK
HEIGHT**12 cm**UZUNLUK
LENGTH**100 cm****PLASTİK
DRENAJ KANAL**PLASTIC
DRAINAGE CHANNELS**MTS 3235****SU ÇIKIŞ SEÇENEKLERİ**
WATER OUTLET OPTIONS

Polipropilen üretilmiş 100 cm uzunluğundaki modüler su kanallarımız tüm özel uygulama ihtiyaçlarına cevap veren komple bir ürün setidir. Birbirine conta ihtiyacı olmadan kilitlenebilen mekanizması sayesinde, estetik yapıdaki dizaynı ile kanal projelerinizde eşsiz bir çözüm sunar.

Our polypropylene 100 cm long modular water drain system is a complete product set that can meet any custom requirement. Thanks to its locking mechanism without any kind of seal between, it can bring unique solutions to any type of drain project along with its artistic view.

MTS 3235**MTS 3335**alt çıkış Ø50 / Ø70 / Ø100
vertical outlet Ø50 / Ø70 / Ø100Ø50 - Ø70 Çıkış
Ø50 - Ø70 Outlet**MTS 3236**13x12 cm
Kanal Tapası
13x12 cm
Channel CapKoli Adedi: 100
Box Quantity:100**MTS 3235**13x100 cm Plastik Kanal
Kanal yüksekliği : 12 cm
13x100 cm Plastic Channel
Channel Height : 12 cm

Koli Adedi: 20 Box Quantity:20

MTS 1037(2)Standart Desen
Plastik Izgara
Standard Pattern
Stainless Grill

Koli Adedi: 40 Box Quantity:40

**MTS 3335**13x100 cm Plastik Kanal - Alt Çıkış
Kanal yüksekliği : 12 cm
13x100 cm Plastic Channel - Vertical Outlet
Channel Height : 12 cm

Koli Adedi: 15 Box Quantity:15

MTS 103913x100 cm Paslanmaz Izgara
Standart Desen
13x100 cm Stainless Grill
Standard Pattern

Koli Adedi: 15 Box Quantity:15

**MTS 3235**13x100 cm Plastik Kanal
Kanal yüksekliği : 12 cm
13x100 cm Plastic Channel
Channel Height : 12 cm

Koli Adedi: 20 Box Quantity:20

MTS 143913x100 cm Standart Desen
Galvaniz Esaslı
13x100 cm Standart Pattern
Galvanised Stainless

Koli Adedi: 15 Box Quantity:15

GENİŞLİK WIDTH	YÜKSEKLİK HEIGHT	UZUNLUK LENGTH
13 cm	7.5 cm	100 cm

PLASTİK SİYAH DRENAJ KANAL

PLASTIC BLACK DRAINAGE CHANNELS

MTS 3035-S



SU ÇIKIŞ SEÇENEKLERİ WATER OUTLET OPTIONS

Polipropilen üretilmiş 100 cm uzunluğundaki modüler su kanallarımız tüm özel uygulama ihtiyaçlarına cevap veren komple bir ürün setidir. Birbirine conta ihtiyacı olmadan kilitlenebilen mekanizması sayesinde, estetik yapıdaki dizaynı ile kanal projelerinizde eşsiz bir çözüm sunar.

Our polypropylene 100 cm long modular water drain system is a complete product set that can meet any custom requirement. Thanks to its locking mechanism without any kind of seal between, it can bring unique solutions to any type of drain project along with its artistic view.



MTS 3035-S

MTS 3135-S

alt çıkış Ø50 / Ø70
vertical outlet Ø50 / Ø70



Ø50 Çıkış
Ø50 Outlet

MTS 1036-S

13x7.5 cm
Kanal Tapası
13x7.5 cm
Channel Cap

Koli Adedi: 100
Box Quantity: 100



MTS 3035-S

13x100 cm Plastik Kanal
Kanal yüksekliği : 7.5 cm
13x100 cm Plastic Channel
Channel Height : 7.5 cm

Koli Adedi: 20 Box Quantity: 20

MTS 1037-S (2)

13x50 cm Standart Desen
Plastik Izgara
13x50 cm Standard Pattern
Stainless Grill

Koli Adedi: 40 Box Quantity: 40



MTS 3035-S

13x100 cm Plastik Kanal
Kanal yüksekliği : 7.5 cm
13x100 cm Plastic Channel
Channel Height : 7.5 cm

Koli Adedi: 20 Box Quantity: 20

MTS 1039

13x100 cm Paslanmaz Izgara
Standart Desen
13x100 cm Stainless Grill
Standard Pattern

Koli Adedi: 20 Box Quantity: 20



MTS 3135-S

13x100 cm Plastik Kanal - Alt Çıkış
Kanal yüksekliği : 7.5 cm
13x100 cm Plastic Channel - Vertical Outlet
Channel Height : 7.5 cm

Koli Adedi: 15 Box Quantity: 15

MTS 1439

13x100 cm Standart Desen
Galvaniz Esaslı
13x100 cm Standard Pattern
Galvanised Stainless

Koli Adedi: 15 Box Quantity: 15

GENİŞLİK
WIDTH

13 cm

YÜKSEKLİK
HEIGHT

12 cm

UZUNLUK
LENGTH

100 cm

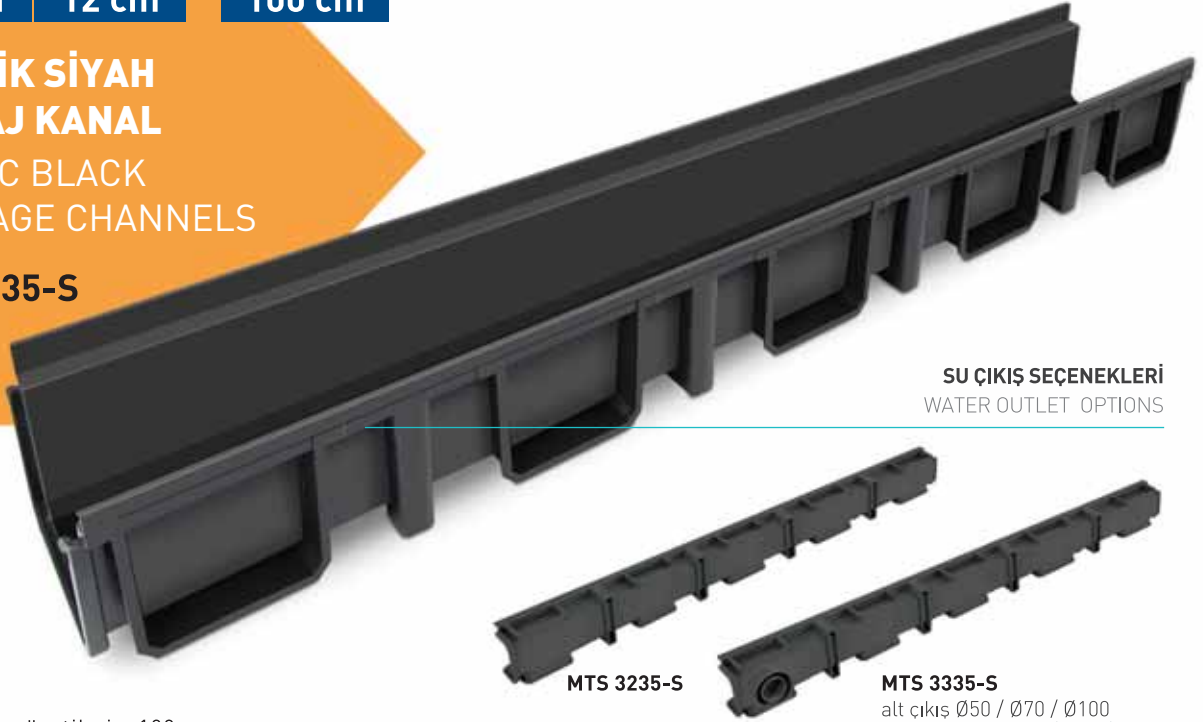
**PLASTİK SİYAH
DRENAJ KANAL**PLASTIC BLACK
DRAINAGE CHANNELS**MTS 3235-S****SU ÇIKIŞ SEÇENEKLERİ**
WATER OUTLET OPTIONS

Polipropilen üretilmiş 100 cm uzunluğundaki modüler su kanallarımız tüm özel uygulama ihtiyaçlarına cevap veren komple bir ürün setidir. Birbirine conta ihtiyacı olmadan kilitlenebilen mekanizması sayesinde, estetik yapıdaki dizaynı ile kanal projelerinizde eşsiz bir çözüm sunar.

Our polypropylene 100 cm long modular water drain system is a complete product set that can meet any custom requirement. Thanks to its locking mechanism without any kind of seal between, it can bring unique solutions to any type of drain project along with its artistic view.

Ø50 - Ø70 Çıkış
Ø50 - Ø70 Outlet**MTS 3236-S**13x12 cm
Kanal Tapası
13x12 cm
Channel CapKoli Adedi: 100
Box Quantity:100**MTS 3235-S**13x100 cm Plastik Kanal
Kanal yüksekliği : 12 cm
13x100 cm Plastic Channel
Channel Height : 12 cm

Koli Adedi: 20 Box Quantity:20

MTS 1037-S (2)13x50 cm Standart Desen
Plastik Izgara
13x50 cm Standard Pattern
Stainless Grill

Koli Adedi: 40 Box Quantity:40

**MTS 3335-S**13x100 cm Plastik Kanal - Alt Çıkış
Kanal yüksekliği : 12 cm
13x100 cm Plastic Channel - Vertical Outlet
Channel Height : 12 cm

Koli Adedi: 15 Box Quantity:15

MTS 103913x100 cm Paslanmaz Izgara
Standart Desen
13x100 cm Stainless Grill
Standard Pattern

Koli Adedi: 15 Box Quantity:15

**MTS 3235-S**13x100 cm Plastik Kanal
Kanal yüksekliği : 12 cm
13x100 cm Plastic Channel
Channel Height : 12 cm

Koli Adedi: 20 Box Quantity:20

MTS 143913x100 cm Standart Desen
Galvaniz Esaslı
13x100 cm Standard Pattern
Galvanised Stainless

Koli Adedi: 15 Box Quantity: 15

drainland®

PLASTİK DRENAJ KANAL 3'LÜ SET

PLASTIC DRAINAGE CHANNEL 3 PIECE SET



MTS 3039 Serisi



Drenaj kanallarımız 3 metre set halinde özel ambalajlı olarak satılmaktadır.

Our drainage channels 3 meters in sets as a special packing It is sold.

3 ADET 1 METRE PLASTİK KANAL
3 PIECES 1 METER PLASTIC CHANNEL

3 ADET 1 METRE İZGARA
3 PIECES 1 METER GRID

2 ADET PLASTİK KANAL TAPASI
3 PIECES PLASTIC CHANNEL TAPASI

MTS 3035-S

MTS 1039

Paslanmaz İzgara
Stainless Grid

MTS 1036-S



MTS 3439 Serisi



Drenaj kanallarımız 3 metre set halinde özel ambalajlı olarak satılmaktadır.

Our drainage channels 3 meters in sets as a special packing It is sold.

3 ADET 1 METRE PLASTİK KANAL
3 PIECES 1 METER PLASTIC CHANNEL

3 ADET 1 METRE İZGARA
3 PIECES 1 METER GRID

2 ADET PLASTİK KANAL TAPASI
3 PIECES PLASTIC CHANNEL TAPASI

MTS 3035-S

MTS 1439

Galvaniz İzgara
Galvanised Grid

MTS 1036-S



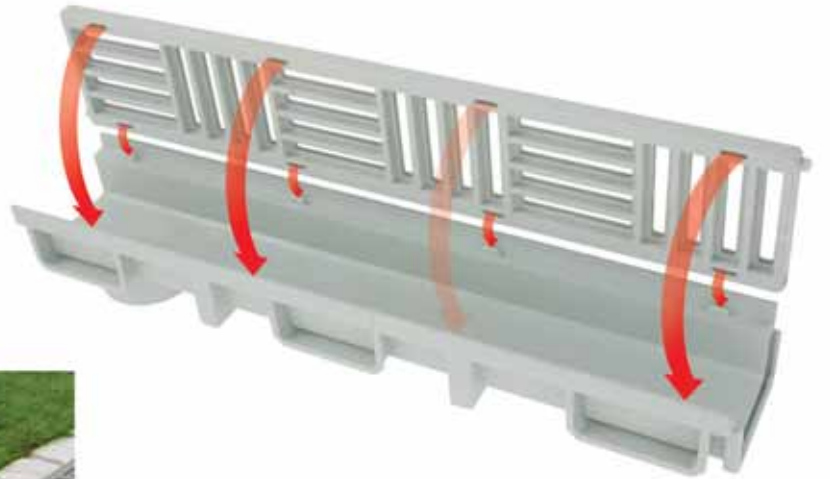

Kanallarımız, kendiliğinden kilitleme sayesinde mükemmel bir aplikasyon sistemi önermektedir. Estetik görünüm gereksinim noktalarında ise paslanmaz ızgaralarımız tercih edilebilir.

Channels, with self-locking System offers a perfect application. In the aesthetic appearance of stainless steel grid should be preferred

DRENAJ KANAL SİSTEMLERİ UYGULAMA DRAINAGE SYSTEMS MODULAR APPLICATION



Kanal zemin yatağı hazırlanır. Zeminde çalışma mesafesi olarak yanaklardan en az 10 cm mesafe bırakılır.

Prepare the ground for channel to place. Work space should be given at least 10 cm from the edges of the channel.



Kanalları birbirine geçiş bağlantı noktalarından birbirine ekleyerek ilerleyebilirsiniz, birleşme yüzeylerinden kaçak olmaması için, bağlantı noktalarına poliüretan esaslı plastik enjekte edebilirsiniz.

By adding ports to each other male-female plastic channels can proceed, the merger surfaces to prevent leakage, the connection points can be injected with silicon applicant.



Kanal kapatma tapaları monte edildikten sonra, tapa üzerindeki çıkış noktası bıçak vb. bir aletle kesilerek çıkış açılır.

Outlet bed can be opened by knife, etc with a device, after outlets are applied to channel.



Boru profiller kanal çıkışlarına monte edilir.

Pipe sections shall be mounted on the channel outputs.

3



Birbirine montaj sıralamasında, kanal yanaklarındaki dişlerin, kanal bitiş yataklarına girmesi sebebiyle, içte kalan kanalların montajı en son yapılır.

Ranking first in assembly, since connection parts at side of channels go thru into channel outlet ends.

4

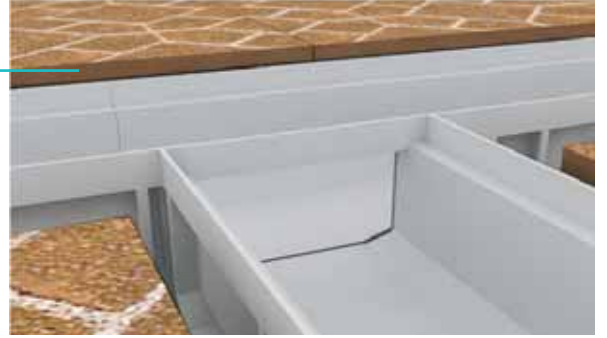

Kanalların birleşimi sırasında sızmaya müsade etmeyecek şekilde montaj olması önemlidir.

It is important that is should not be allowed to infiltrate the assembly during the combination of channels.

7



Kanal üst düzleminin seviyesine yaklaşık 3-4 cm gibi mesafeye kadar, kaplama malzemesinin kalınlığı da esas alınarak, kanalın sağ ve sol kenarlarından beton doldurulur. Beton uygulaması esnasında kanal ızgarasının, kanala yerleşmiş olması önemlidir.

Up to a distance of approximately 3 - 4 cm, such as the level of the top plane of the channel, based on the thickness of the coating material, right and left edges of the channel filled with concrete. Concrete implementation of the channel during the grill, the channel is important to be settled with grill.

DRENAJ KANAL SİSTEMLERİ TEKNİK DETAYLAR

DRAINAGE SYSTEMS MODULAR TECHNICAL DETAILS

Tam sızdırmazlık sağlamak için kanalların birleşim yerlerinde poliüretan esaslı mastik kullanılması tavsiye edilir.

To obtain a total waterproofing, it is recommended to apply polyurethane based mastic for the joints of drain modules.

Kanallarımız, küçük kanallarda 6 adet yan çıkışa, büyük kanallarda 4 adet yan çıkışa sahip olduğundan istenilen noktadan 90 derece dönüş T çıkış ve (+) şekile sahip kanal sistemleri oluşturulabilir.

Our small channel modules have 6, large channel modules have 4 horizontal outlets. Thus, at a desired point, a 90 turn, or a "T" shaped, or a Cross connection can be obtained.

Yan çıkışlardan bağlantı yapıldıktan sonra zayıflatılmış bölgeler kırılarak suyun geçiş alanı açılır.

Once horizontal outlet is connected to the next module, the attenuated part is broken out to let water flow.

Modüler su kanalları bağlantı şekilleri

Modular water channels connections



90° Dönüştü Kanal
90° Reflexive Channel

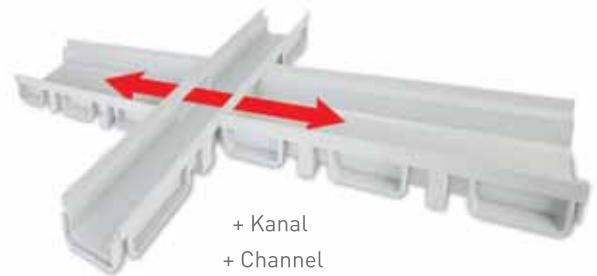

+ Kanal
+ Channel

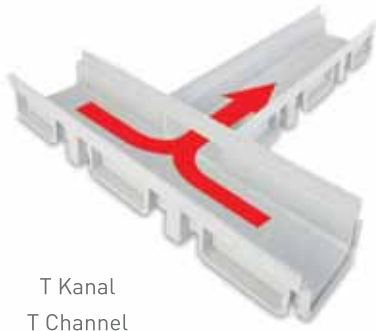

T Kanal
T Channel

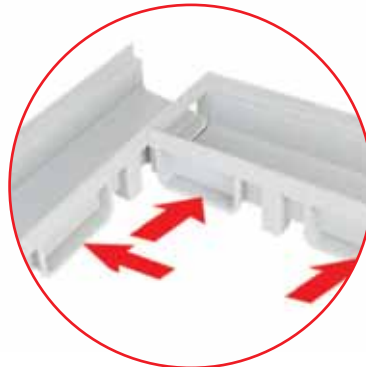

Kanal birleşimlerinde (su akışını sağlamak için) kolay kırılma alanları oluşturulmuştur.

In order to obtain easy flow, channels designed with easy break areas at its sides.

DRENAJ KANAL SİSTEMLERİ TEKNİK DETAYLAR

DRAINAGE SYSTEMS MODULAR TECHNICAL DETAILS

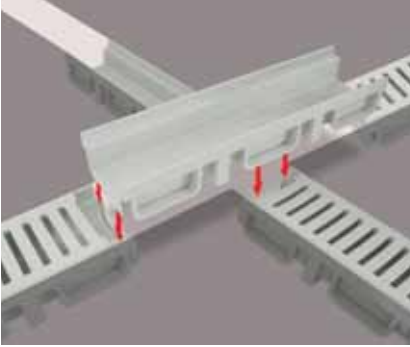

Artı şeklindeki uygulamalarda orta birleştirme parçası en son eklenmelidir.

At applications of a plus-shaped, middle part of the merge should be added to the end.

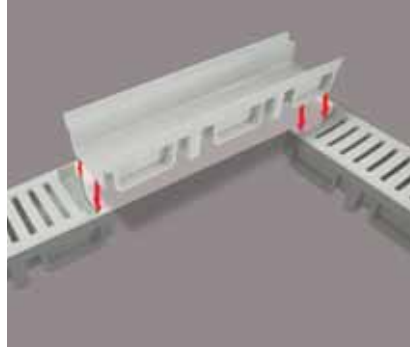

L (Köşe Dönüş) şeklindeki uygulamalarda köşe birleştirme parçası en son eklenmelidir.

At applications of a L-shaped, last part of the merge should be added to the end.

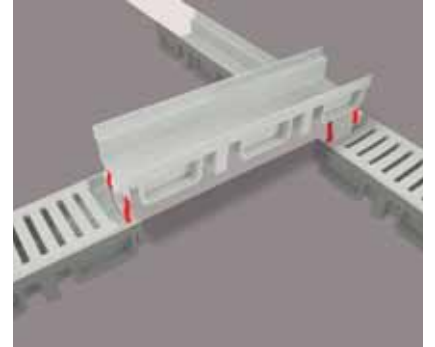

T şeklindeki uygulamalarda köşe birleştirme parçası en son eklenmelidir.

At applications of a T-shaped, corner part of the merge should be added to the end.



Oluk birleşmelerini, erkek ve dişi taraflarını denk getirip, yivler vasıtasıyla üstten bastırarak oturtunuz.

Combinations of groove, bringing the equivalent male and female sides, ribs pressing through the top snaps.

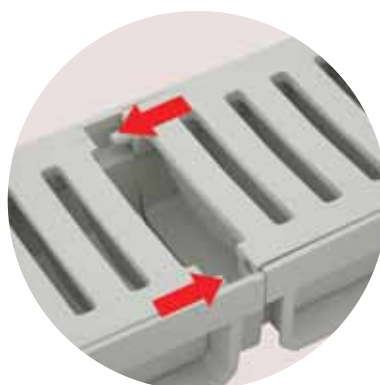

Izgara birleşmelerini, pim ve pim yuvalarını denk getirip, iterek birleştiriniz.

Mergers of the grid, corresponding to bring pins and sockets, push the pipe end.

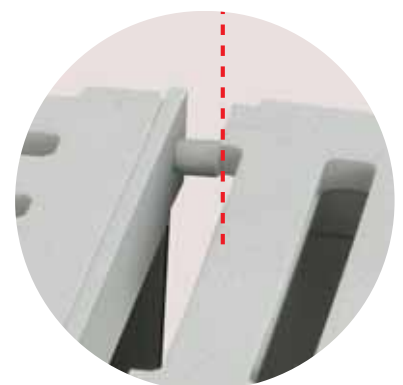

+, T ve L birleşmelerinde ızgaranın karşıyan yüzeye sıfır oturabilmesi için pim tırnağının kırılması gerekmektedir.

+, T and L type of mergers of the grid, for the pin against the side of the nail to break the surface should be fully fit.



POLİMER KANALLAR
POLYMER CHANNELS



**OVAL TİP
SU AKIŞ YATAĞI**
OVAL TYPE
WATER WAY



50 cm
UZUNLUK
LENGHT

**DÜZ TİP
SU AKIŞ YATAĞI**
FLAT TYPE
WATER WAY



100 cm
UZUNLUK
LENGHT

Polimer kanallarımız, proje detaylarına göre klasik veya çıtalı olarak üretilebilmektedir. 2016 yılı itibarıyla, oval kesit kanal imalatına da başlamış bulunmaktayız. 13x8 cm ve 20x20 cm kesitindeki ürünlerimizi düz kesit veya oval kesit seçenekleri ile satışa sunmaktayız.

Polymer channels, according to the project details, can be produced as flat shape or round . As of 2016, we have started manufacturing oval section type polymer channels. For now, flat section or oval section type polymer channels are in sale for 20x20 cm and 13x8 cm.



İstenilen tüm ürün boylarında demir bağlantı kilitleme yapılabilmektedir.

For all inquired product size are available with connection for locking.



Talebe göre çıtalı ürünler üretilebilir.

Slotted products are available on demand.

10 cm GENİŞLİK
WIDTH

POLİMER KANAL
POLYMER
CHANNELS



IZGARA SEÇENEKLERİ
GRILL OPTIONS



MTS 2037

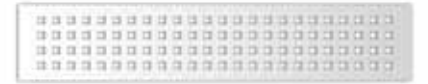

MTS 2138



50 cm POLİMER KANAL
50 cm POLYMER CHANNEL

KOD CODE	GENİŞLİK WIDTH	YÜKSEKLİK HEIGHT	UZUNLUK LENGTH	AÇIKLAMA DESCRIPTION
MPK 1006-1	10 cm	6 cm	50 cm	Klasik - Classic
MPK 1008-1	10 cm	8 cm	50 cm	Klasik - Classic



100 cm POLİMER KANAL
100 cm POLYMER CHANNEL

KOD CODE	GENİŞLİK WIDTH	YÜKSEKLİK HEIGHT	UZUNLUK LENGTH	AÇIKLAMA DESCRIPTION
MPK 1006	10 cm	6 cm	100 cm	Klasik - Classic
MPK 1008	10 cm	8 cm	100 cm	Klasik - Classic

13 cm GENİŞLİK
WIDTH

POLİMER KANAL
POLYMER
CHANNELS



IZGARA SEÇENEKLERİ
GRILL OPTIONS



304 Kalite Paslanmaz
304 Quality Stainless Steel **MTS 1138**



Plastik
Plastic **MTS 1037**



304 Kalite Paslanmaz
304 Quality Stainless Steel **MTS 1038**



Galvaniz Esaslı
Galvanised Stainless **MTS 1438**

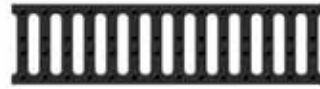

Sfero Döküm
Cast Iron Grill **MDI 1350**



50 cm POLİMER KANAL
50 cm POLYMER CHANNEL

KOD CODE	GENİŞLİK WIDTH	YÜKSEKLİK HEIGHT	UZUNLUK LENGTH	AÇIKLAMA DESCRIPTION
MPK 1306-1	13 cm	6 cm	50 cm	Klasik - Classic
MPK 1308-1	13 cm	8 cm	50 cm	Klasik - Classic
MPK 1310-1	13 cm	10 cm	50 cm	Klasik - Classic
MPK 1315-1	13 cm	15 cm	50 cm	Klasik - Classic
MPK 1320-1	13 cm	20 cm	50 cm	Klasik - Classic
MPÇ 1306-1	13 cm	6 cm	50 cm	Çıtalı - Slotted
MPÇ 1308-1	13 cm	8 cm	50 cm	Çıtalı - Slotted
MPÇ 1310-1	13 cm	10 cm	50 cm	Çıtalı - Slotted
MPÇ 1315-1	13 cm	15 cm	50 cm	Çıtalı - Slotted
MPÇ 1320-1	13 cm	20 cm	50 cm	Çıtalı - Slotted



100 cm POLİMER KANAL
100 cm POLYMER CHANNEL

KOD CODE	GENİŞLİK WIDTH	YÜKSEKLİK HEIGHT	UZUNLUK LENGTH	AÇIKLAMA DESCRIPTION
MPK 1306	13 cm	6 cm	100 cm	Klasik - Classic
MPK 1308	13 cm	8 cm	100 cm	Klasik - Classic
MPK 1310	13 cm	10 cm	100 cm	Klasik - Classic
MPK 1315	13 cm	15 cm	100 cm	Klasik - Classic
MPK 1320	13 cm	20 cm	100 cm	Klasik - Classic
MPÇ 1306	13 cm	6 cm	100 cm	Çıtalı - Slotted
MPÇ 1308	13 cm	8 cm	100 cm	Çıtalı - Slotted
MPÇ 1310	13 cm	10 cm	100 cm	Çıtalı - Slotted
MPÇ 1315	13 cm	15 cm	100 cm	Çıtalı - Slotted
MPÇ 1320	13 cm	20 cm	100 cm	Çıtalı - Slotted

20 cm GENİŞLİK
WIDTH

POLİMER KANAL
POLYMER
CHANNELS



IZGARA SEÇENEKLERİ
GRILL OPTIONS



MTS 1044
Plastik
Plastic



MTS 1040
304 Kalite Paslanmaz
304 Quality Stainless Steel



MTS 1440
Galvaniz Esaslı
Galvanised Stainless



MDI 2050
Sfero Döküm
Cast Iron Grill



50 cm POLİMER KANAL
50 cm POLYMER CHANNEL

KOD CODE	GENİŞLİK WIDTH	YÜKSEKLİK HEIGHT	UZUNLUK LENGTH	AÇIKLAMA DESCRIPTION
MPK 2006-1	20 cm	6 cm	50 cm	Klasik - Classic
MPK 2008-1	20 cm	8 cm	50 cm	Klasik - Classic
MPK 2012-1	20 cm	12 cm	50 cm	Klasik - Classic
MPK 2015-1	20 cm	15 cm	50 cm	Klasik - Classic
MPK 2020-1	20 cm	20 cm	50 cm	Klasik - Classic
MPK 2024-1	20 cm	24 cm	50 cm	Klasik - Classic
MPÇ 2006-1	20 cm	6 cm	50 cm	Çıtalı - Slotted
MPÇ 2008-1	20 cm	8 cm	50 cm	Çıtalı - Slotted
MPÇ 2012-1	20 cm	12 cm	50 cm	Çıtalı - Slotted
MPÇ 2015-1	20 cm	15 cm	50 cm	Çıtalı - Slotted
MPÇ 2020-1	20 cm	20 cm	50 cm	Çıtalı - Slotted
MPÇ 2025-1	20 cm	25 cm	50 cm	Çıtalı - Slotted
MPÇ 2030-1	20 cm	30 cm	50 cm	Çıtalı - Slotted
MPÇ 2040-1	20 cm	40 cm	50 cm	Çıtalı - Slotted



100 cm POLİMER KANAL
100 cm POLYMER CHANNEL

KOD CODE	GENİŞLİK WIDTH	YÜKSEKLİK HEIGHT	UZUNLUK LENGTH	AÇIKLAMA DESCRIPTION
MPK 2006	20 cm	6 cm	100 cm	Klasik - Classic
MPK 2008	20 cm	8 cm	100 cm	Klasik - Classic
MPK 2012	20 cm	12 cm	100 cm	Klasik - Classic
MPK 2015	20 cm	15 cm	100 cm	Klasik - Classic
MPK 2020	20 cm	20 cm	100 cm	Klasik - Classic
MPK 2024	20 cm	24 cm	100 cm	Klasik - Classic
MPÇ 2006	20 cm	6 cm	100 cm	Çıtalı - Slotted
MPÇ 2008	20 cm	8 cm	100 cm	Çıtalı - Slotted
MPÇ 2012	20 cm	12 cm	100 cm	Çıtalı - Slotted
MPÇ 2015	20 cm	15 cm	100 cm	Çıtalı - Slotted
MPÇ 2020	20 cm	20 cm	100 cm	Çıtalı - Slotted
MPÇ 2025	20 cm	25 cm	100 cm	Çıtalı - Slotted
MPÇ 2030	20 cm	30 cm	100 cm	Çıtalı - Slotted
MPÇ 2040	20 cm	40 cm	100 cm	Çıtalı - Slotted

25 cm GENİŞLİK
WIDTH

POLİMER KANAL
POLYMER
CHANNELS

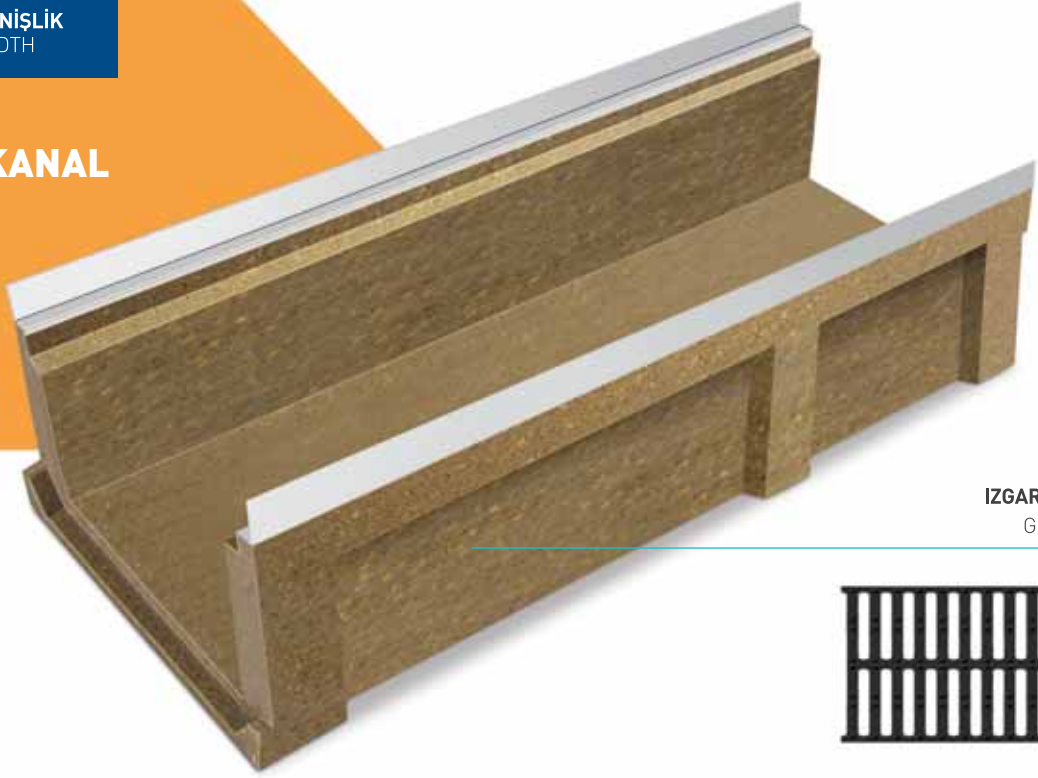

IZGARA SEÇENEĞİ
GRILL OPTION



MDI 2550



50 cm POLİMER KANAL
50 cm POLYMER CHANNEL

KOD CODE	GENİŞLİK WIDTH	YÜKSEKLİK HEIGHT	UZUNLUK LENGTH	AÇIKLAMA DESCRIPTION
MPÇ 2508-1	25 cm	8 cm	50 cm	Çıtalı - Slotted
MPÇ 2520-1	25 cm	20 cm	50 cm	Çıtalı - Slotted
MPÇ 2540-1	25 cm	40 cm	50 cm	Çıtalı - Slotted



100 cm POLİMER KANAL
100 cm POLYMER CHANNEL

KOD CODE	GENİŞLİK WIDTH	YÜKSEKLİK HEIGHT	UZUNLUK LENGTH	AÇIKLAMA DESCRIPTION
MPÇ 2508	25 cm	8 cm	100 cm	Çıtalı - Slotted
MPÇ 2520	25 cm	20 cm	100 cm	Çıtalı - Slotted
MPÇ 2540	25 cm	40 cm	100 cm	Çıtalı - Slotted

30 cm GENİŞLİK
WIDTH

POLİMER KANAL
POLYMER
CHANNELS



IZGARA SEÇENEĞİ
GRILL OPTION

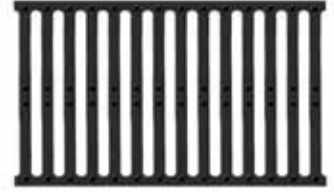

MDI 3050



50 cm POLİMER KANAL
50 cm POLYMER CHANNEL

KOD CODE	GENİŞLİK WIDTH	YÜKSEKLİK HEIGHT	UZUNLUK LENGTH	AÇIKLAMA DESCRIPTION
MPK 3008-1	30 cm	8 cm	50 cm	Klasik - Classic
MPK 3015-1	30 cm	15 cm	50 cm	Klasik - Classic
MPC 3008-1	30 cm	8 cm	50 cm	Çıtalı - Slotted
MPC 3012-1	30 cm	11 cm	50 cm	Çıtalı - Slotted
MPC 3015-1	30 cm	15 cm	50 cm	Çıtalı - Slotted
MPC 3020-1	30 cm	20 cm	50 cm	Çıtalı - Slotted
MPC 3025-1	30 cm	25 cm	50 cm	Çıtalı - Slotted



100 cm POLİMER KANAL
100 cm POLYMER CHANNEL

KOD CODE	GENİŞLİK WIDTH	YÜKSEKLİK HEIGHT	UZUNLUK LENGTH	AÇIKLAMA DESCRIPTION
MPK 3008	30 cm	8 cm	100 cm	Klasik - Classic
MPK 3015	30 cm	15 cm	100 cm	Klasik - Classic
MPC 3008	30 cm	8 cm	100 cm	Çıtalı - Slotted
MPC 3012	30 cm	11 cm	100 cm	Çıtalı - Slotted
MPC 3015	30 cm	15 cm	100 cm	Çıtalı - Slotted
MPC 3020	30 cm	20 cm	100 cm	Çıtalı - Slotted
MPC 3025	30 cm	25 cm	100 cm	Çıtalı - Slotted

40 cm GENİŞLİK
WIDTH

POLİMER KANAL
POLYMER
CHANNELS



IZGARA SEÇENEĞİ
GRILL OPTION

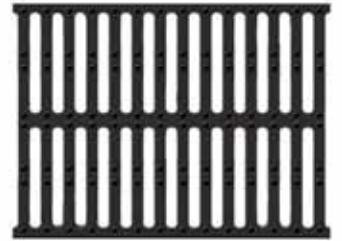

MDI 4050



50 cm POLİMER KANAL
50 cm POLYMER CHANNEL

KOD CODE	GENİŞLİK WIDTH	YÜKSEKLİK HEIGHT	UZUNLUK LENGTH	AÇIKLAMA DESCRIPTION
MPÇ 4020-1	40 cm	20 cm	50 cm	Çıtalı - Slotted
MPÇ 4030-1	40 cm	30 cm	50 cm	Çıtalı - Slotted
MPÇ 4040-1	40 cm	40 cm	50 cm	Çıtalı - Slotted



100 cm POLİMER KANAL
100 cm POLYMER CHANNEL

KOD CODE	GENİŞLİK WIDTH	YÜKSEKLİK HEIGHT	UZUNLUK LENGTH	AÇIKLAMA DESCRIPTION
MPÇ 4020	40 cm	20 cm	100 cm	Çıtalı - Slotted
MPÇ 4030	40 cm	30 cm	100 cm	Çıtalı - Slotted
MPÇ 4040	40 cm	40 cm	100 cm	Çıtalı - Slotted

POLİMER KANAL SİSTEMLERİ UYGULAMA

POLYMER CHANNEL SYSTEMS MODULAR APPLICATION

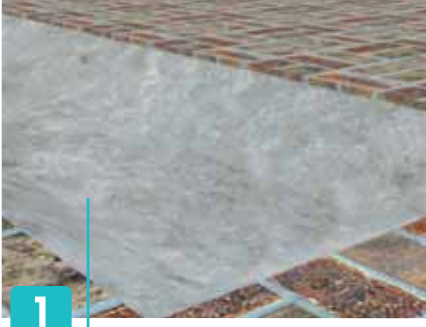

1 Polimer beton kanal uygulamasının ilk ve en önemli adımı; polimer kanalın yerleştirileceği kanal / zemin yatağının hazırlanmasıdır. Şayet zemin yatağı gevşek veya istenen tonajı sağlayabilecek yapıda değilse, zeminde hasır demiri veya benzeri uygulamalarla zemin iyileştirilmesi yapılmalıdır.

The first and most important step in the application of polymer concrete channel, prepare the ground for polymer channel to place the channel to bed. If the ground is loose or not the bearing structure can provide the required tonnage, iron wire mesh or similar applications should be made to improve on the ground floor.



2 Montaj sıralamasında ilk olarak, varsa alttan çıkışlı veya yandan boru-profil bağlantılarının belirlenmesi, kanalın ilk sabitleme noktasının belirleyici olması açısından daha doğru olur. Bu noktadan sonra dikkat etmeniz gereken husus ise, eğimin, zemin yatağı boyunca, projenin talebine göre düzenlenmesi gereğidir.

Given the slope of the concrete, polymer fluid will pass through the channel and the slope ratio is regulated. Ranking first in assembly, if any, from the bottom or the side pipe-profile connections, the channel would be more accurate in terms of the first fixing point is decisive. What is needed to pay attention to this point, the slope, along the bed floor, according to the demand of the project is by arrangement.



3 Polimer kanalları erkek-dişi bağlantı noktalarından birbirine ekleyerek ilerleyebilirsiniz, birleşme yüzeylerinden kaçak olmaması için, bağlantı noktalarına silikon enjekte edebilirsiniz.

By adding ports to each other male-female polymer channels can proceed, the merger surfaces to prevent leakage, the connection points can be injected with the silicon applicant.



4 Kanal üst düzleminin seviyesine yaklaşık 3-4 cm gibi mesafeye kadar kaplama malzemesinin kalınlığı da esas alınarak, kanalın sağ ve sol kenarlarından beton doldurulur.

Up to a distance of approximately 3-4 cm, such as the level of the top plane of the channel, based on the thickness of the coating material, right and left edges of the channel filled with concrete.



5 Beton uygulaması esnasında kanal ızgarasının, kanala yerleşmiş olması önemlidir. Çünkü, doldurulan betonun yaptığı yanal baskı kanalın, ızgara ağzının daralmasına yol açabilir.

Concrete implementation of the channel during the grille, the channel is important to be settled with grill. Because the lateral pressure of concrete filled in the channel, the grid can lead to narrowing of the mouth.



6 Son işlem olarak, kanalın seviyeleri kontrol edilir. Bu noktada, kanalın zemin yatağında tam olarak yerleşmesi için, bir ahşap parçasının desteğini alıp, çekiç (vb. bir aletle) ile baskı / darbe yapılarak kanal yatağa yerleştirilir.

Coating as a share of Excluded from the study, instead of coating material are also turned off by placing the concrete. In recent trading, the channel levels are controlled. At this point, in full settlement of the channel bed to the floor, backing away a piece of wood, hammer (etc. with a device) and the pressure / pulse by the bed is placed in the channel.

POLİMER KANAL TAHLİYE ÇAP DETAYLARI

POLYMER CHANNEL DIAMETER EVACUATION DETAILS

BİTİŞ TAPA TAHLİYE ÇAP DETAYI

END CAP DISCHARGE DIAMETER DETAIL

100 mm GENİŞLİK POLİMER KANALLAR - 100 mm WIDTH OF POLYMER CHANNELS

MPK 1006	Ø 32 mm
MPK 1008	Ø 32 mm - Ø 50 mm

130 mm GENİŞLİK POLİMER KANALLAR - 130 mm WIDTH OF POLYMER CHANNELS

MPK 1306	Ø 32 mm
MPK 1308	Ø 32 mm - Ø 50 mm
MPK 1310	Ø 50 mm - Ø 70 mm
MPK 1315	Ø 50 mm - Ø 70 mm - Ø 100 mm
MPK 1320	Ø 50 mm - Ø 70 mm - Ø 100 mm

200 mm GENİŞLİK POLİMER KANALLAR - 200 mm WIDTH OF POLYMER CHANNELS

MPK 2006	Ø 32 mm
MPK 2008	Ø 32 mm - Ø 50 mm
MPK 2012	Ø 50 mm - Ø 70 mm
MPK 2015	Ø 50 mm - Ø 70 mm - Ø 100 mm
MPK 2020	Ø 50 mm - Ø 70 mm - Ø 100 mm
MPK 2024	Ø 50 mm - Ø 70 mm - Ø 100 mm - Ø 125 mm

250 mm GENİŞLİK POLİMER KANALLAR - 250 mm WIDTH OF POLYMER CHANNELS

MPÇ 2520	Ø 50 mm - Ø 70 mm - Ø 100 mm
MPÇ 2540	Ø 50 mm - Ø 70 mm - Ø 100 mm - Ø 125 mm

300 mm GENİŞLİK POLİMER KANALLAR - 300 mm WIDTH OF POLYMER CHANNELS

MPÇ 3008	Ø 32 mm
MPÇ 3010	Ø 32 mm - Ø 50 mm - Ø 70 mm
MPÇ 3015	Ø 50 mm - Ø 70 mm - Ø 100 mm
MPÇ 3025	Ø 50 mm - Ø 70 mm - Ø 100 mm - Ø 125 mm - Ø 150 mm

400 mm GENİŞLİK POLİMER KANALLAR - 400 mm WIDTH OF POLYMER CHANNELS

MPÇ 4020	Ø 50 mm - Ø 70 mm - Ø 100 mm - Ø 125 mm - Ø 150 mm
MPÇ 4030	Ø 50 mm - Ø 70 mm - Ø 100 mm - Ø 125 mm - Ø 150 mm - Ø 200 mm

ALT ÇIKIŞ TAHLİYE ÇAP DETAYI

BOTTOM OUTLET DISCHARGE DIAMETER DETAIL

Ø 50 mm - Ø 70 mm

Ø 50 mm - Ø 70 mm

Ø 50 mm - Ø 70 mm

Ø 50 mm - Ø 70 mm

Ø 50 mm - Ø 70 mm

Ø 50 mm - Ø 70 mm

Ø 50 mm - Ø 70 mm

Ø 50 mm - Ø 70 mm - Ø 100 mm - Ø 125 mm - Ø 150 mm

Ø 50 mm - Ø 70 mm - Ø 100 mm - Ø 125 mm - Ø 150 mm

Ø 50 mm - Ø 70 mm - Ø 100 mm - Ø 125 mm - Ø 150 mm

Ø 50 mm - Ø 70 mm - Ø 100 mm - Ø 125 mm - Ø 150 mm

Ø 50 mm - Ø 70 mm - Ø 100 mm - Ø 125 mm - Ø 150 mm

Ø 50 mm - Ø 70 mm - Ø 100 mm - Ø 125 mm - Ø 150 mm

Ø 50 mm - Ø 70 mm - Ø 100 mm - Ø 125 mm - Ø 150 mm

Ø 50 mm - Ø 70 mm - Ø 100 mm - Ø 125 mm - Ø 150 mm

Ø 50 mm - Ø 70 mm - Ø 100 mm - Ø 125 mm - Ø 150 mm - Ø 200 mm

Ø 50 mm - Ø 70 mm - Ø 100 mm - Ø 125 mm - Ø 150 mm - Ø 200 mm

Ø 50 mm - Ø 70 mm - Ø 100 mm - Ø 125 mm - Ø 150 mm - Ø 200 mm

Ø 50 mm - Ø 70 mm - Ø 100 mm - Ø 125 mm - Ø 150 mm - Ø 200 mm

Ø 50 mm - Ø 70 mm - Ø 100 mm - Ø 125 mm - Ø 150 mm - Ø 200 mm

Ø 50 mm - Ø 70 mm - Ø 100 mm - Ø 125 mm - Ø 150 mm - Ø 200 mm

drainland®

**DRENAJ KANAL
IZGARALARI**

DRAINAGE
CHANNEL
GRILLS

 **Mesateknik**

**DÖKÜM
IZGARALAR**
CAST IRON GRILL



MDI 1350

Genişlik : 130 mm
Uzunluk : 500 mm
Kalınlık : 20 mm
Width : 130 mm
Length : 500 mm
Thickness : 20 mm

Koli Adedi: 1
Box Quantity:1

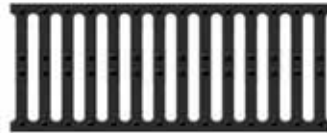

MDI 2050

Genişlik : 200 mm
Uzunluk : 500 mm
Kalınlık : 20 mm
Width : 200 mm
Length : 500 mm
Thickness : 20 mm

Koli Adedi: 1
Box Quantity:1

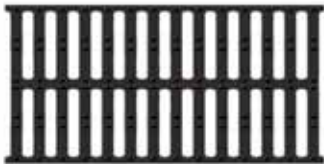

MDI 2550

Genişlik : 250 mm
Uzunluk : 500 mm
Kalınlık : 35 mm
Width : 250 mm
Length : 500 mm
Thickness : 35 mm

Koli Adedi: 1
Box Quantity:1

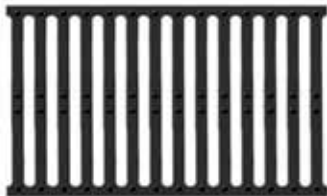

MDI 3050

Genişlik : 300 mm
Uzunluk : 500 mm
Kalınlık : 35 mm
Width : 300 mm
Length : 500 mm
Thickness : 35 mm

Koli Adedi: 1
Box Quantity:1

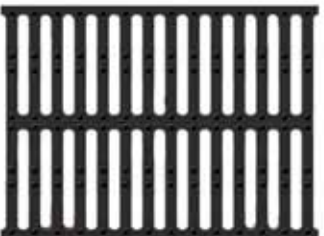

MDI 4050

Genişlik : 400 mm
Uzunluk : 500 mm
Kalınlık : 45 mm
Width : 400 mm
Length : 500 mm
Thickness : 45 mm

Koli Adedi: 1
Box Quantity:1

**304 KALİTE
PASLANMAZ
IZGARALAR**
304 QUALITY
STAINLESS
GRILL



7x50 cm



2070 - 01

7x50 cm
Dolu Desen
7x50 cm
Full Pattern

Koli Adedi: 40
Box Quantity:40



2070 - 02

7x50 cm
Reyn Desen
7x50 cm
Reyn Pattern

Koli Adedi: 40
Box Quantity:40



2070 - 03

7x50 cm
Rekta Desen
7x50 cm
Rekta Pattern

Koli Adedi: 40
Box Quantity:40



2070 - 04

7x50 cm
Balık Desen
7x50 cm
Balık Pattern

Koli Adedi: 40
Box Quantity:40



2070 - 05

7x50 cm
Labirent Desen
7x50 cm
Labirent Pattern

Koli Adedi: 40
Box Quantity:40



2070 - 06

7x50 cm
Kare Desen
7x50 cm
Kare Pattern

Koli Adedi: 40
Box Quantity:40



2070 - 07

7x50 cm
Autobahn Desen
7x50 cm
Autobahn Pattern

Koli Adedi: 40
Box Quantity:40



10x50 cm

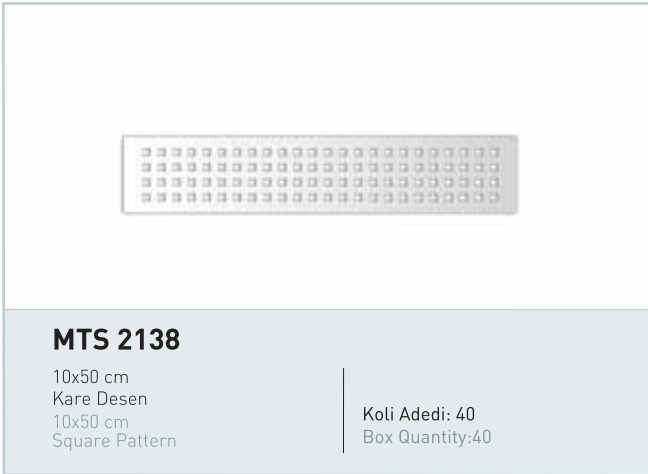

13x50 cm

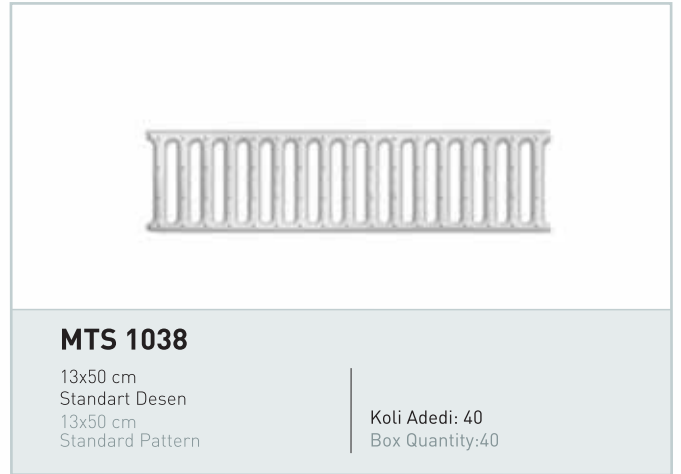

20x50 cm

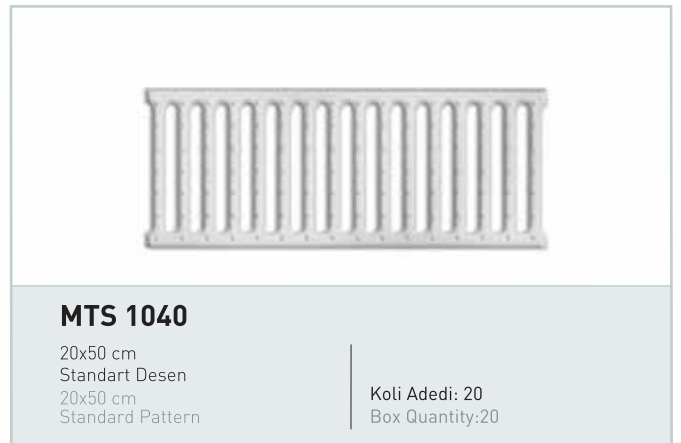

Paslanmaz ızgara ile uyumlu drenaj sistemleri;
Hijyen, yüzey düzgünlüğü, fonksiyonel güvenlik
ve malzeme dayanımının en üst noktada istendiği
zaman kullanılabilir en iyi çözümlerden birisidir.

Drain systems concordant to stainless grates;
One of the best solutions to obtain hygiene,
smooth surfaces, functional security and material
endurance at top level.

**304 KALİTE
PASLANMAZ IZGARA VE
GALVANİZ IZGARALAR**

304 QUALITY
STAINLESS GRILL
GALVANISED
MATERIEL GRILL



Paslanmaz ızgara ile uyumlu drenaj sistemleri;
Hijyen, yüzey düzgünlüğü, fonksiyonel güvenlik
ve malzeme dayanımının en üst noktada istendiği
zaman kullanılabilecek en iyi çözümlerden birisidir.

Drain systems concordant to stainless grates;
One of the best solutions to obtain hygiene,
smooth surfaces, functional security and material
endurance at top level.

13x50 cm

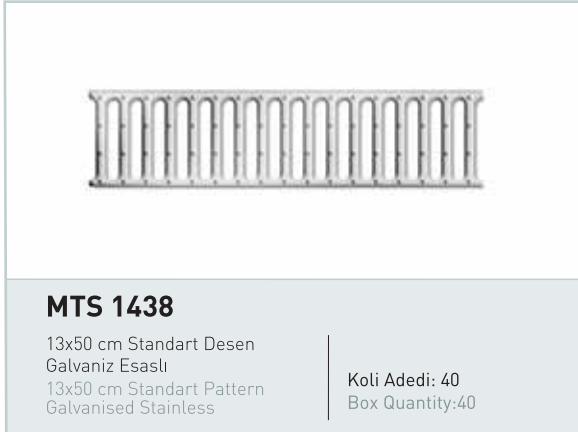

20x50 cm



13x100 cm

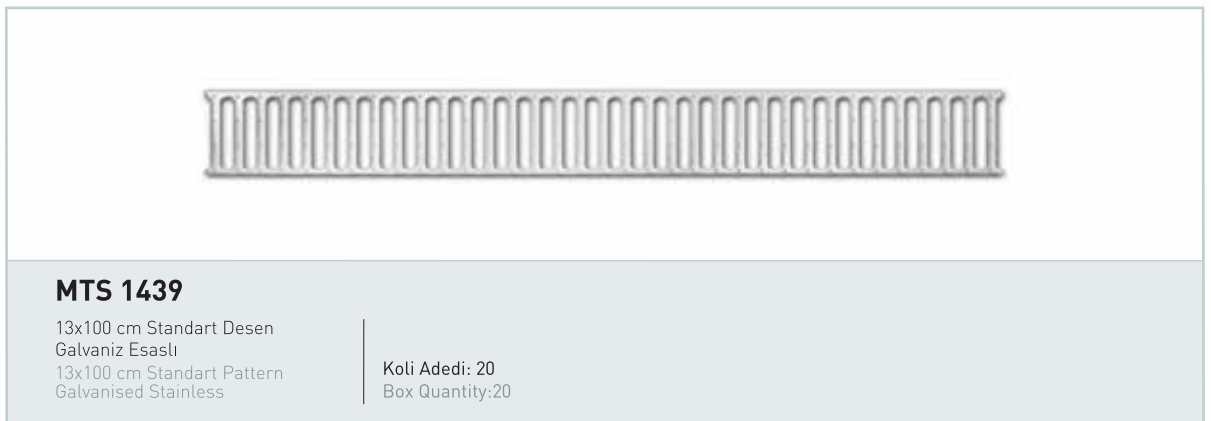
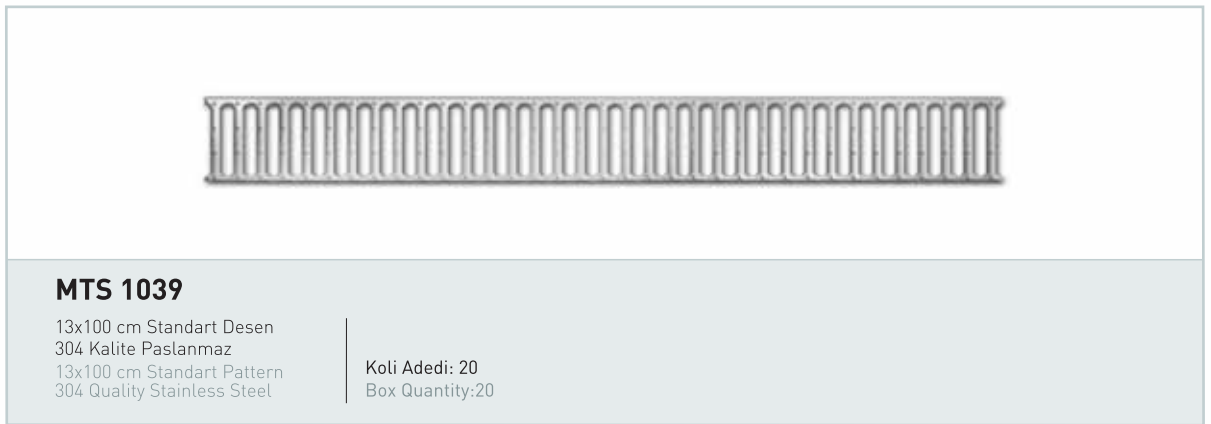

**OLUKLU
IZGARA
SİSTEMLERİ**
CORRUGATED
GRATE
SYSTEMS



MSL serisi olarak ürettiğimiz bu kanal modeli polimer kanalların üst kısmına istenilen h yüksekliğinde ve ızgara genişliği ile özel olarak imal edilir. Bu seride öncelikle, drenaj yapılacak akışkana göre kanal kesiti seçilir ve uygulanacak döşeme yüksekliği ve oluklu ızgara genişliği belirlenerek imalat yapılır.

MSL series - the new SLIMLINE series in production - of corrugated grates can be produced for the desired polymer drain, at desired height "h", and at desired grate width. For this series of grates, first of all, drain cross section is determined according to the fluid to be drained. Then, paving height and corrugated grate width is determined and production starts.



Merkez inişli
Central rolling

Köşe inişli
Corner rolling



Kullanılan kanal genişliği ve derinliğine göre, proje departmanı yetkililerinin uygun gördüğü metrajlarda, istasyon amacıyla temizleme haznesi konulmalıdır. Uzunluğu 50 cm'dir.

According to the channel width and depth, for the quantity deemed by authorities of the project department, cleaning chambers should be used as stop stations the length is 50 cm.

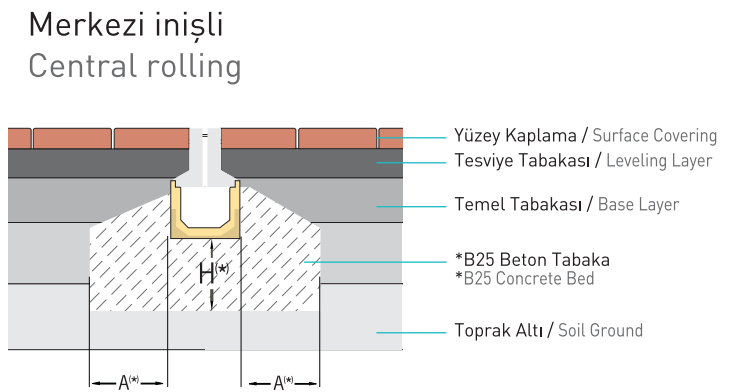
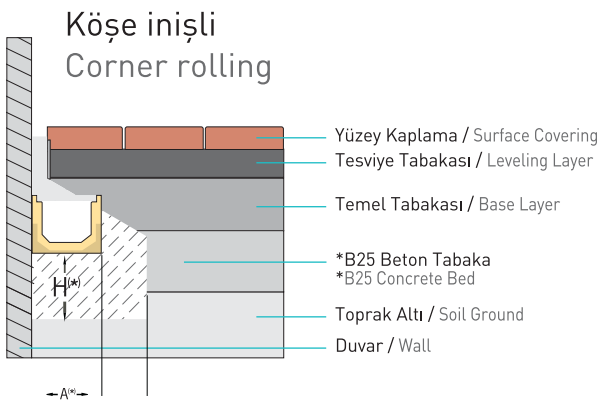

H^(), A^(*)

Kanal montajı esnasında, kanalın toprak altına ve zemin yatağında kenarlara olan mesafesi kanalın alacağı yük esas alınarak düzenlenir.

During the assembly of the channel, the distance from the to channel bed and distance to sides of the channel under the soil and the distance to the ground, on the basis of the load will be exposed to the channel, can be regulated.

B25 Tavsiye edilen beton sınıfı. B25 Recommended Concrete class

**POINT DRAIN
SIFONLU
SÜZGEÇLER**
POINT DRAIN
SIPHONIC
DRAINS



PD-PK 1508

15x15x8 cm
Pik döküm ızgaralı alt çıkışı Ø70
Cast iron grill vertical outlet Ø70

Koli Adedi: 1
Box Quantity : 1

Polimer gövdeli, isteğe göre paslanmaz veya pik döküm ızgaralı, sifonlu yer süzgeçleri. 15 x 15, 20 x 20, 30 x 30 veya 20 x 50 ebatlarındaki süzgeçlerimiz, dik inişli sistemle, yüksek su debisi istenen ve kapalı otopark gibi ağır yük altında kalması muhtemel noktalarda, projenizde çözüm ortağı olur. Iızgara seçenekleri; pik döküm veya paslanmaz esastır.

Cast Iron Roof and Terrace Drains, are used particularly at large roof areas, between isolation sheet and the pipe end. The pebble holder within the body part prevents the filtering pebbles from escaping into the profile, plus, it creates the required distance with the grid or leaf holder. Cleaning caps; can be used to reach the waste water line in case of clogging.



PD-PK 2008

20x20x8 cm
Pik döküm ızgaralı alt çıkışı Ø100
Cast iron grill vertical outlet Ø100

Koli Adedi: 1
Box Quantity : 1



PD-PK 2012

20x20x12 cm
Pik döküm ızgaralı alt çıkışı Ø100
Cast iron grill vertical outlet Ø100

Koli Adedi: 1
Box Quantity : 1



PD-PK 3008

30x30x8 cm
Pik döküm ızgaralı alt çıkışlı Ø150
Cast iron grill vertical outlet Ø150

Koli Adedi: 1
Box Quantity : 1



PD-PK 3012

30x30x12 cm
Pik döküm ızgaralı alt çıkışlı Ø150
Cast iron grill vertical outlet Ø150

Koli Adedi: 1
Box Quantity : 1



PD-PK 3040

30x30x40 cm
Pik döküm ızgaralı yan çıkışlı Ø100
Cast iron grill horizontal outlet Ø100

Koli Adedi: 1
Box Quantity : 1



PD-D

20x50x12 cm
Pik döküm ızgaralı alt çıkışlı Ø100
Cast iron grill vertical outlet Ø100

Koli Adedi: 1
Box Quantity : 1



PD-P

20x50x12 cm
Paslanmaz ızgaralı alt çıkışlı Ø100
Stainless grill vertical outlet Ø100

Koli Adedi: 1
Box Quantity : 1

YAN ÇIKIŞ TAHLİYE ÇAP DETAYI SIDE OUTLET DISCHARGE DIAMETER DETAIL

PD-PK 1508	-
PD-PK 2008	-
PD-PK 2012	Ø 50 mm - Ø 70 mm
PD-GL 2008	-
PD-GL 2012	Ø 50 mm - Ø 70 mm
PD-PK 3008	-
PD-PK 3012	Ø 50 mm - Ø 70 mm
PD-PK 3040	Ø 50 mm - Ø 70 mm - Ø 100 mm

ALT ÇIKIŞ TAHLİYE ÇAP DETAYI BOTTOM OUTLET DISCHARGE DIAMETER DETAIL

Ø 50 mm - Ø 70 mm
Ø 50 mm - Ø 70 mm - Ø 100 mm
Ø 50 mm - Ø 70 mm - Ø 100 mm
Ø 50 mm - Ø 70 mm
Ø 50 mm - Ø 70 mm - Ø 100 mm
Ø 50 mm - Ø 70 mm - Ø 100 mm - Ø 125 mm - Ø 150 mm
Ø 50 mm - Ø 70 mm - Ø 100 mm - Ø 125 mm
Ø 50 mm - Ø 70 mm - Ø 100 mm - Ø 125 mm

**IRON DRAIN
SİFONLU
SÜZGEÇLER
IRON DRAIN
SIPHONIC
DRAINS**



Pik Döküm Çatı ve Teras Süzgeçleri, özellikle geniş çatılı alanlarda yalıtım örtüsü ile profilin başlandığı noktada kullanılır. Süzgeç gövdesinde bulunan çakıl tutucu sayesinde, suyun filtrelenmesinde kullanılan çakılın profilin içine gitmesini engellenirken, ayrıca ızgara veya yaprak tutucu için istenen mesafe korunmuş olur.

Cast Iron Roof and Terrace Drains, are used particularly at large roof areas, between isolation sheet and the pipe end. The pebble holder within the body part prevents the filtering pebbles from escaping into the profile, plus, it creates the required distance with the grid or leaf holder.

Temizleme tapaları; Pis su hattına ulaşarak, hat boyunca akışı engelleyecek durumlarda, istasyonlarda kullanılabilir.

Cleaning caps; can be used to reach the waste water line in case of clogging.



PK - PK 2002

20x20
Ø 70mm
Alttan Çıkışlı
Pik döküm gövdeli
Pik Döküm Iızgaralı
Clean Plung

Koli Adedi: 1
Box Quantity : 1



PK - PK 2048

20x20
Ø 100mm
Alttan Çıkışlı
Pik döküm gövdeli
Pik Döküm Iızgaralı
Clean Plung

Koli Adedi: 1
Box Quantity : 1



MPD 1048

Ø100 mm
Pik döküm çatı süzgeci
Yaprak tutuculu
Cast iron roof - Leaf holder

Koli Adedi: 1
Box Quantity : 1



MPD 1148

Ø100 mm
Pik döküm çatı süzgeci Iızgaralı
Cast iron roof Filter

Koli Adedi: 1
Box Quantity : 1



MPD 1027

Ø100 mm
Pik döküm çatı süzgeci
Parapet çıkışlı
Cast iron roof - Parapet outlet

Koli Adedi: 1
Box Quantity : 1



MTT 1002

Ø70 mm
Temizlik tapası
Clean Plung

Koli Adedi: 1
Box Quantity : 1



MTT 1048

Ø100 mm
Temizlik tapası
Clean Plung

Koli Adedi: 1
Box Quantity : 1



drainland®

KİLİTLENEBİLEN GERİ TEPMESİZ ÇEKVALF

BACK WATER VALVE



Bu ürün grubu ambalajlı olarak satılmaktadır.
This product group as packaged sold.

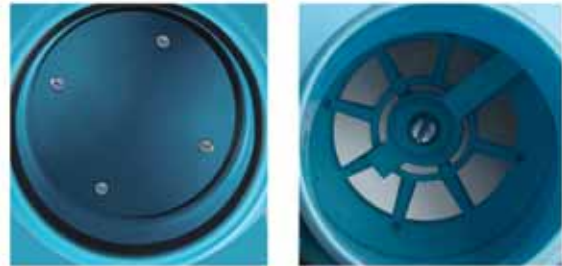

Kilitlenebilir, paslanmaz kapağı sayesinde su tepmelerini önler
Thanks to its lockable stainless steel cover, prevents water rebound

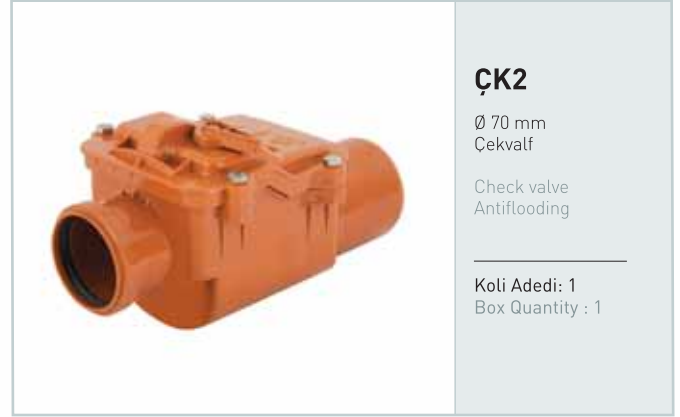

Açık / Open

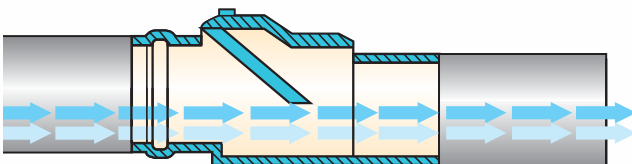

Kapalı / Closed

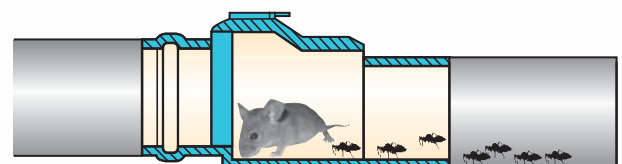

Özel kilitli yapısı sayesinde, atık su geri tepmelerin ve haşerelerin bina içerisine girmesini önler.

Its custom lockable design, check valve prevents counter flows and insects from running into the building.

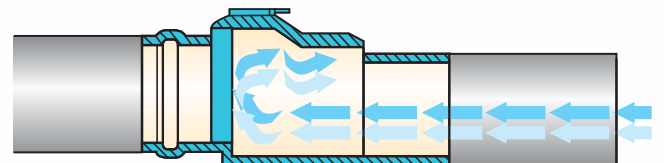

**RÖGAR
KUTUSU**
MANHOLE
AND ANTI
FLOODING



MTR 20

200x200 mm
Rögar set
(kutu+kapak)
Manhole set
(box+cover)

Koli Adedi: 1
Box Quantity : 1



MTR 30

300x300 mm
Rögar set
(kutu+kapak)
Manhole set
(box+cover)

Koli Adedi: 1
Box Quantity : 1



MTR 35

350x350 mm
Rögar set
(kutu+kapak)
Manhole set
(box+cover)

Koli Adedi: 1
Box Quantity : 1



MTR 40

400x400 mm
Rögar set
(kutu+kapak)
Manhole set
(box+cover)

Koli Adedi: 1
Box Quantity : 1



MTR 50

500x500 mm
Rögar set
(kutu+kapak)
Manhole set
(box+cover)

Koli Adedi: 1
Box Quantity : 1



MTR 55

550x550 mm
Rögar set
(kutu+kapak)
Manhole set
(box+cover)

Koli Adedi: 1
Box Quantity : 1

**KOMPOZİT
KARE KAPAK**
COMPOSITE
SQUARE COVER



MKK 56
56x56 cm - B 125
MKK 56
56x56 cm - C 250



MKK 67
67x67 cm - B 125
MKK 67
67x67 cm - C 250



MKK 80 80x80 cm - B125
MKK 80 80x80 cm - C250
MKK 80 80x80 cm - D400



POLİMER MENHOL KAPAK

POLYMER
MENHOLE
COVER



Polimer esaslı memhol kapaklarımız bahçe ve açık alanlarınızda rögar kutularınızı gizlemek amacıyla kullanılır. Basınç dayanımının artırılması için polyester esaslı malzemeye fiber elyaf katkı yapılmıştır. Malzemeye ait net genişlik ve yükseklik bilgileri için proje departmanımızdan yardım alabilirsiniz. Polimer menhol tipi kapaklarımız bahçe tipi yerlerde kullanılır, ağır yük tonajı için tavsiye edilmez.

Polymer based manhole covers are used to hide the manholes within gardens and open areas. In order to increase their resistance to pressure, polyester based material is reinforced with fiber. Please consult to our project department for certain information on width and thickness of the material. Polymer type of manhole covers that are used in applications where a garden-type polymer, are not recommended for heavy load tonnage



MMK R75
Ø 75 cm

Koli Adedi: 1
Box Quantity : 1



MMK D50
50x50 cm

Koli Adedi: 1
Box Quantity : 1



MMK D75
75x75 cm

Koli Adedi: 1
Box Quantity : 1

**DÖŞEME
UYUMLU
GİZLEME KAPAĞI**
UPHOLSTERY
COMPATIBLE
CONCEALMENT
COVER



MGK 33
33 cm

Koli Adedi: 1
Box Quantity : 1



MGK 40
40 cm

Koli Adedi: 1
Box Quantity : 1



MGK 60
60 cm

Koli Adedi: 1
Box Quantity : 1



MGK 80
80 cm

Koli Adedi: 1
Box Quantity : 1



KOMPOZİT ÇERÇEVELİ KAPAK COMPOSITE FRAME COVER



Kompozit kare kapaklar, elyaf ile güçlendirilmiş plastik malzemeler olarak; yüksek mukavemeti, anti korozyon yapısı, birçok kimyasala karşı gösterdikleri direnç ve yüksek UV stabilitesi sayesinde günümüzde yapı malzemeleri dünyasında yer almaya başlamışlardır.

- Pürüzsüz yüzey,
- Projeye göre istenen renkte üretilebilme özelliği,
- Uzun ömürlü ve bakım gereksinimleri düşük,
- Proje alanında montaj olabileme ve modifikasyon edilebilme özelliği
- Uygulama zamanı ve düşük maliyetli olması, projeler açısından tercih sebebidir

Made of fiber reinforced plastic material and with their high endurance, non corrosive structure, high resistance to many type of chemicals and high UV stability, composite square covers start to play an important role in contemporary construction materials.

- Their
- Smooth surface,
- Productibility in desired colour,
- Long life and less maintenance requirements, mountability and modifiability at construction site,
- Law costs and shorter application time, makes composite square covers preferable for different type of projects.

